

Operating Instructions

Battery rescue tools

S-FORCE



SPS 270 MK2 S-FORCE, SPS 360 MK2 S-FORCE, SPS 370 MK2 S-FORCE, SPS 400 MK2 S-FORCE, SPS 480 MK2 S-FORCE, RIT-TOOL S-FORCE, RSC 170 S-FORCE, RSC 170 PLUS S-FORCE, RSC 190 S-FORCE, RSC 190 PLUS S-FORCE, RSC 200 S-FORCE, RSC 200 PLUS S-FORCE, RSC F7 S-FORCE, SP 44 AS S-FORCE, SP 54 AS S-FORCE, SP 50 BS S-FORCE, RZ 1-910 S-FORCE, RZT 2-1170 S-FORCE, RZT 2-1360 S-FORCE, RZT 2-1500 S-FORCE

1103421



www.weber-rescue.com

WEBERRESCUE
SYSTEMS

Inhalt

1. General

1.1 Information on the operating instructions	4
1.2 Explanation of symbols	5
1.3 Limitation of liability	6
1.4 Copyright	6
1.5 Warranty provisions	7
1.6 Customer Service	7

2. Safety **8**

2.1 Intended use	8
2.2 Operator responsibility	10
2.3 Operating personnel	11
2.4 Personal protective equipment	12
2.5 Particular hazards	13
2.6 Conduct in dangerous situations and accidents	15
2.7 Signage	16

3. Technical specifications **17**

3.1 Combi tools	17
3.2 Cutters	18
3.3 Spreaders	19
3.4 Rescue rams	20
3.5 Operating conditions	20
3.6 Type plate	20
3.4 Rescue rams	20

4. Structure and function **21**

4.1 Overview of SMART-FORCE equipment	21
4.2 Cutter	22
4.3 Rescue rams	23
4.4 Spreaders	24
4.5 Hydraulic supply	25
4.6 Electrical supply, using a combi tool as an example	26
4.7 Underwater use	26
4.8 Communication module and radio connection	28
4.9 Operating SMART-FORCE equipment	30
4.11 Device registration for SMART-FORCE rescue devices	31
4.12 Accessories	32
4.13 Replacing blade inserts (PLUS)	35
4.14 Replacing the spreader tips	37

5. Applications	38
5.1 Safety instructions	38
5.2 Cutting (cutters, combi tools)	38
5.3 Pressing (rescue rams)	39
5.4 Spreading (spreaders, combi tools)	40
5.5 Pulling (spreaders, combi tools, rescue rams)	41
5.6 Squeezing (spreaders, combi tools)	42
5.7 Lifting (spreaders, combi tools, rescue rams)	43
5.8 Peeling (spreaders, combi tools, rescue rams)	43
5.9 Pressing (combination appliances with RZM)	43
6 Battery and charger	44
6.1 Charger technical data	44
6.2 Special safety instructions	44
6.3 Intended use	46
6.4 Mains connection	46
6.5 Li-ion battery	46
6.7 Maintenance	48
7 Transport, packaging and storage	49
7.1 Safety instructions	49
7.2 Transport inspection	49
7.3 Symbols on the packaging	50
7.4 Disposal of packaging	50
7.5 Storage	50
8 Installation and commissioning	51
8.1 Safety instructions	51
8.2 Checks	51
8.3 Shut-down (end of work)	52
8.4 Advantages of device registration	53
9 Maintenance	54
9.1 Safety instructions	54
9.2 Upkeep and maintenance	54
9.3 Maintenance after operation in humidity	55
9.4 Maintenance after underwater use	55
9.5 Maintenance schedule	55
10 Malfunctions & faults	56
11 Decommissioning / recycling	58
12 EC Declaration of Conformity	59

1. General

1.1 Information on the operating instructions

These operating instructions provide important information on using SMART-FORCE equipment. To assure safety at the workplace, always observe all safety and handling instructions contained in this document.

Furthermore, the local Health & Safety guidelines and applicable risk assessments, to the operation site of the equipment must also be observed.

Before starting any work you must read these operating instructions thoroughly! They are a component of the product and must be stored in a known location that is accessible to personnel at all times.

This documentation contains information about the operation of your tool, regardless of which type of tool it is. For this reason, you will also find explanations that do not relate directly to your tool.

All information, technical specifications, graphics and illustrations contained in these Operating Instructions are based on the most up-to-date data available at the time these instructions were created.

In addition to thoroughly reading the operating instructions, we also recommend that you undergo training and instruction in handling (possible uses, operational tactics, etc.) the rescue equipment from one of our qualified trainers.



NOTE!

The current version of the operating instructions can be found on our website
<https://www.weber-rescue.com/>
or by scanning the QR code.



1.2 Explanation of symbols

Warnings

In these operating instructions, warnings are identified by symbols.

The individual warnings are introduced by signal words expressing the degree of danger.

These warnings must be followed to prevent accidents, injury and property damage.



DANGER!

... points out an immediately dangerous situation which can cause death or severe injury if it is not avoided.



WARNING!

...points out a potentially dangerous situation which can cause death or severe injury if it is not avoided.



CAUTION!

...points out a potentially dangerous situation which can cause minor or slight injury if it is not avoided.



ATTENTION!

...points out a potentially dangerous situation which can cause property damage if it is not avoided.

Tips and recommendations



NOTE!

...emphasises useful tips and information for efficient, trouble-free operation.

1.3 Limitation of liability

All information and instructions in these operating instructions were compiled under consideration of the applicable standards and regulations, the current state of technology and our long-standing knowledge and experience.

The manufacturer assumes no liability for damages due to:

- Non-observance of the operating instructions
- Improper use
- Assigning untrained personnel
- Unauthorised modifications
- Technical changes
- Use of impermissible replacement parts
- Use of non-original accessories

For special designs or due to technical changes, the actual scope of supply for may differ from the explanations and representations described.

1.4 Copyright

All texts, illustrations, drawings and images in these operating instructions may be used freely without prior authorisation.

**NOTE!**

Additional information, images and diagrams are available on our home page: www.weber-rescue.com.

1.5 Warranty provisions

The warranty provisions are included with the sales documentation as a separate document.

1.6 Customer Service

Our Customer Service would be happy to provide you with technical information.

Germany

Service Center, Güglingen
 Phone: +49 7135 71 10112
 E-mail: servicecenter@weber-rescue.com

Austria

Service Center, Losenstein
 Phone: +43 7255 6237-12473
 E-mail: ATL.Servicecenter@weber-rescue.com

International

For questions regarding spare parts, service and repair, please contact our certified local service partners. Scan the following QR code for an overview of our worldwide service and sales network.

**NOTE!**

When contacting our Customer Service, please provide the identification, type and year of manufacture of the equipment. This information can be found on the type plate.

For further processing, please complete the RMA document in full:



2. Safety

This section of the operating instructions presents a comprehensive overview of all important safety aspects for optimal protection of the operating personnel as well as for safe, trouble-free operation.

Non-observance of the handling and safety instructions presented in these Operating Instructions can result in serious dangers.

2.1 Intended use

The hydraulic battery tools are designed and tested exclusively for the intended applications described here. All other activities are fundamentally prohibited.

All battery tools are designed as one-person tool and are therefore to be operated by only one person.

Cutters (RSC 170 S-FORCE, RSC 170 PLUS S-FORCE, RSC 190 S-FORCE, RSC 190 PLUS S-FORCE, RSC 200 S-FORCE, RSC 200 PLUS S-FORCE, RSC F7 S-FORCE)

- The battery-powered cutting tool are used exclusively for cutting doors and roof beams, pillars and door sills, the ring and the spokes of the steering wheel.
- If possible, for cutting solid material, always use the rear part of the cutter blades as it is equipped with special edges for cutting round material.
- In industrial application, the equipment can also be used to cut pipes, structural steels, profiles, sheets and cables.

Spreaders (SP 44 AS S-FORCE, SP 54 AS S-FORCE, SP 50 BS S-FORCE)

- The battery-powered spreading tools can be used for opening doors, lifting vehicles or other moveable loads, pushing away and moving vehicle parts and loads, and squeezing pipes and tie bars.
- If possible, always use the tips of the spreader for squeezing.
- The spreader tips can also be used as a peeling tool.
- The chain set is solely to be used for pulling.

Combi tools (SPS 270 MK2 S-FORCE, SPS 360 MK2 S-FORCE, SPS 370 MK2 S-FORCE, SPS 400 MK2 S-FORCE, SPS 480 MK2 S-FORCE, RIT-TOOL S-FORCE)

- The battery-powered combi tools may be used for the specified purposes of both the cutters and the spreaders. The spreader tips can also be used as a peeling tool.

Rescue rams (RZ 1-910 S-FORCE, RZT 2-1170 S-FORCE, RZT 2-1360 S-FORCE, RZT 2-1500 S-FORCE)

- The tools are used to lift and push up steering columns, vehicle roofs and other vehicle parts.
- In addition, under certain conditions and whilst exercising particular care, rescue rams can be used for support, lifting and stiffening.

Accessories - chain sets

- Spreaders and combi tools may only be used with the appropriate chain set and pulling device. Pulling chains are exclusively for pulling away obstacles and loads and for enlarging openings to free trapped persons.



WARNING!

Danger caused by improper use!

Any use other than intended use and/or other type of use of these tool can cause dangerous situations!

Therefore, it is absolutely necessary to:

- » Only use the tool for the intended uses described above.
- » Observe all other information regarding proper use of the tools in Chapter 5 (Possible uses).



NOTE!

All S-FORCE equipment (cutters, spreaders, combi tools and rescue rams) are intended for use in the professional or industrial sector and not for private use!

**NOTE!**

S-FORCE devices contain a communication module, which is required for the WLAN, LTE and GPS for communication and location determination.

More detailed information on the communication module and the radio connections and channels used can be found in section 4.7.

2.2 Operator responsibility

In addition to the occupational safety information in these operating instructions, the health & safety, accident prevention and environmental prevention, guidelines and regulations applicable to the operation site of the equipment must also be observed. Thereby, the following applies in particular:

- The operator must inform himself regarding the applicable occupational safety regulations and carry out a risk assessment to identify additional dangers arising from the special work conditions at the operation site of the tool.
- The operator must clearly regulate and determine responsibility for installation, maintenance and cleaning.
- The operator must ensure that all persons engaged with the tool have completely read and understood the operating instructions.
- Furthermore, they must train the personnel at regular intervals and inform them of the dangers associated with handling the tool.

The operator is also responsible for ensuring that the equipment is always in a technically flawless condition. Therefore, the following applies:

- After each time the equipment is used, or at least once a year, a visual inspection of the tool by an instructed person is required (per DGUV guideline 305-002 or country-specific rules).
- Every three years, or whenever a doubt is raised about the safety or reliability of the tool, a function and load test must also be carried out (per DGUV guideline 305-002 or country-specific regulations).
- After each use, but at least once a year, check the seal on the battery cover and the housing in the sealing area for cracks and damage. Lubricate the seal with colourless lubricant WD40 or MegaÖl Plus with PTM.
- The tool must be tested for leaks at least once a year or if there is any doubt about its reliability.

2.3 Operating personnel

The following qualifications for different areas of activity are specified in the operating instructions:

- **Instructed persons**
Have been instructed by the operator regarding the tasks they have been assigned and the possible dangers caused by improper actions.
- **Expert personnel**
Because of their professional training, knowledge and experience as well as their knowledge of the applicable manufacturer's provisions, expert personnel are able to carry out the tasks they have been assigned and independently recognize potential dangers.



WARNING!

Danger of injury caused by insufficient qualifications!

Improper handling of these tools can cause serious injury and property damage.

Therefore, it is absolutely necessary to:

- » Only permit the people specified in the respective chapters of these operating instructions to carry out the special activity.
- » In case of doubt, immediately call in expert personnel.



NOTE!

Never operate the tool after consuming alcohol, medications or drugs!



NOTE!

Maintenance work can be carried out by instructed persons. Maintenance measures and repairs may only be carried out by the tool manufacturer, or by specialist personnel trained by the tool manufacturer and the authorised service partners. Continuous training and instruction by the tool manufacturer is mandatory for a valid training certificate.

2.4 Personal protective equipment

To minimise danger for the operating personnel, wearing personal protective equipment (PPE) when handling the hydraulic rescue equipment is absolutely mandatory.

As a matter of principle, always wear the following protective clothing for all work:



Safety work clothing

Only wear closely fitting work clothing with narrow sleeves and without projecting pieces while working. This is primarily for protection against entanglement in moving parts of the equipment.



Safety shoes

Always wear steel-capped safety shoes to protect against heavy falling objects and slipping on slippery surfaces.



Work gloves

Wear safety work gloves to protect against sharp edges and glass splinters when operating the equipment.



Helmet with face shield

Wear a helmet with face shield to protect against flying or falling parts and glass splinters.



Protective goggles

In addition to a face mask, protective goggles should be worn to protect the eyes from projectile particles.

Also wear during any special kinds of work that cause noise:



Ear defenders

To protect your hearing, ear defenders should be worn in addition to personal protective equipment.

2.5 Particular hazards

The dangers resulting from the risk assessment are presented in the following section.

To minimize potential health hazards and prevent dangerous situations, the safety instructions listed below and the warning instructions in the following chapters of these Operating Instructions must be observed.

Electrical current



DANGER!

Danger of death due to electrical current!

There is an immediate danger of death if live parts are touched. Damage to insulation or individual components can be life-threatening.

Therefore:

- » If the insulation is damaged, immediately disconnect the power supply and arrange for repairs.
- » Only allow electricians to carry out work on the electrical system.
- » When any work is being carried out on the electrical system, it must be disconnected from the mains supply and checked to ensure that it is not live.
- » Before carrying out maintenance, cleaning or repair work, the power supply must be switched off and secured to prevent it being switched on again.
- » Do not bypass or shut down any fuses.
Use fuses with the correct amperage when replacing.
- » Keep live parts away from moisture.
This can cause a short circuit.



WARNING!

The use of SMART-FORCE tools in potentially explosive atmospheres is prohibited.

Noise



WARNING!
Damage to hearing caused by noise

The noise arising in the working area can cause serious damage to the hearing.

Therefore:

- » Also wear ear defenders during any special kinds of work that cause noise.
- » Only wear the ear defenders while you are in the danger area.

Hydraulic energy



WARNING!
Danger due to hydraulic energy!

The hydraulic forces that are released and escaping hydraulic fluid can cause severe injuries.

Therefore:

- » Always keep the tool in sight while working and put it down if necessary.
- » Inspect hose lines and tools for damage after each use.
- » Avoid skin contact with the hydraulic oil (wear safety gloves).
- » Remove hydraulic oil from wounds without delay and consult a doctor immediately.

2.6 Conduct in dangerous situations and accidents

Preventive measures

- Always be prepared for accidents
- Always have first-aid equipment (first-aid kit, blankets, etc.) within reach
- Familiarise personnel with accident reporting, first aid and rescue equipment
- Keep access routes for rescue vehicles open

In case of incidents

- Immediately shut down tools
- Initiate first-aid measures
- Remove persons from the danger zone
- Inform responsible person at the operation site
- Alarm doctor and/or fire brigade
- Open access routes for rescue vehicles

2.7 Signage

The following symbols and instruction panels are located on the equipment. They refer to the immediate environment in which they are displayed.



Please note contents of operating instructions

Do not use the designated tool until you have read the operating instructions from cover to cover.



WARNING!

Danger of injury due to illegible symbols!

As time goes by, adhesive labels and symbols on the tool may get dirty, or be rendered illegible in some other manner.

Therefore, it is absolutely necessary to:

- » Maintain all safety, warning and operating instructions on the tool in a readily legible condition.
- » Damaged signs and adhesive labels must be replaced immediately.

3. Technical specifications

3.1 Combi tools



SPS 270 MK2 S-FORCE



SPS 360 MK2 S-FORCE



SPS 370 MK2 S-FORCE



SPS 400 MK2 S-FORCE



SPS 480 MK2 S-FORCE



RIT-TOOL S-FORCE

	SPS 270 MK2 S-FORCE	SPS 360 MK2 S-FORCE	SPS 370 MK2 S-FORCE	SPS 400 MK2 S-FORCE	SPS 480 MK2 S-FORCE	RIT-TOOL S-FORCE
Length	827 mm	943 mm	949 mm	988 mm	1076 mm	790 mm
Width	192 mm	236 mm	236 mm	236 mm	263 mm	192 mm
Height	228 mm	228 mm	228mm	228 mm	228 mm	228 mm
Weight (ready for use)	14,6 kg	18,9 kg	19,7 kg	21,7 kg	25,6 kg	14,3 kg
Opening width	221 mm	285 mm	295 mm	343 mm	402 mm	215 mm
Pulling width (with adapter)	395 mm	440 mm	410mm	450 mm	525 mm	320 mm
Expansion force in the working area*	31 - 591 kN	36 - 783 kN	35 - 783 kN	35 - 1071 kN	45 - 1600 kN	30 - 1.305 kN
Max. pulling force	36 kN	53 kN	56 kN	58 kN	78 kN	47,0 kN
Nominal pressure	700 bar	700 bar	700 bar	700 bar	700 bar	700 bar
EN class**	BK31/270G-14,6	CK36/360I-18,9	CK35/370H-19,7	CK35/405I-21,7	CK45/480K-25,6	AC140H-14,3
NFPA class	A6-B7-C6-D7-E7-F3	A7-B8-C7-D9- E8-F5	A7-B8-C7-D8- E8-F5	A7-B9-C7-D9- E9-F6	A8-B9-C9-D9- E9-F7	A6-B7-C6-D7- E7-F3
ID no.	1101470	1101471	1101472	1100144	1101554	1101159

* per EN 13204:2016

** in accordance with EN 13204:2016

3.2 Cutters

RSC 170 S-FORCE

RSC 170 PLUS S-FORCE

RSC 190 S-FORCE

RSC 190 PLUS S-FORCE

RSC 200 S-FORCE

RSC 200 PLUS S-FORCE

RSC F7 S-FORCE

	RSC 170 S-FORCE	RSC 170 PLUS S-FORCE	RSC 190 S-FORCE	RSC 190 PLUS S-FORCE
Length	908 mm	908mm	936 mm	936 mm
Width	236 mm	236 mm	236 mm	236 mm
Height	228 mm	228mm	228mm	228 mm
Weight (ready for use)	19,0 kg	20,1 kg	21,5 kg	22,7 kg
Opening width	175 mm	175 mm	187 mm	187 mm
Nominal pressure	700 bar	700 bar	700 bar	700 bar
EN class**	BC166I-19,0	BC166I-20,1	BC187K-21,5	BC187K-22,7
NFPA class	A7-B8-C6-D8-E9-F4	A7-B8-C6-D8-E9-F4	A8-B9-C7-D9-E9-F4	A8-B9-C7-D9-E9-F4
ID no.	1101547	1101548	1101549	1101550

* per EN 13204:2016

** in accordance with EN 13204:2016

	RSC 200 S-FORCE	RSC 200 PLUS S-FORCE	RSC F7 S-FORCE
Length	1003 mm	1003 mm	1066 mm
Width	296 mm	296 mm	295 mm
Height	228 mm	228 mm	228 mm
Weight (ready for use)	25,6 kg	26,9 kg	27,9 kg
Opening width	202 mm	202 mm	300 mm
Nominal pressure	700 bar	700 bar	700 bar
EN class**	CC202K-25,6	CC202K-26,9	CC268K-27,9
NFPA class	A9-B9-C9-D9-E9-F5	A9-B9-C9-D9-E9-F5	A9-B9-C9-D9-E9-F7
ID no.	1101551	1101552	1101553

* per EN 13204:2016

** in accordance with EN 13204:2016

3.3 Spreaders



SP 44 AS S-FORCE



SP 50 AS S-FORCE



SP 54 AS S-FORCE

	SP 44 AS S-FORCE	SP 50 BS S-FORCE	SP 54 AS S-FORCE
Length	893 mm	1032 mm	999 mm
Width	239 mm	282 mm	282 mm
Height	228 mm	228 mm	228 mm
Weight (ready for use)	18,2 kg	21,8 kg	21,6 kg
Spreading width	610 mm	805 mm	735 mm
Pulling width	465 mm	680 mm	620 mm
Spreading force in the working area*	44 - 857 kN	50 - 501 kN	55 - 501 kN
Max. pulling force	68 kN	67 kN	70 kN
Max. squeezing force*	149,0 kN	144,0 kN	144,0 kN
Nominal pressure	700 bar	700 bar	700 bar
EN class**	AS44/610-18,2	BS50/805-21,8	AS55/735-21,6
ID no.	1101468	1100143	1101469

* per EN 13204:2016

** in accordance with EN 13204:2016

3.4 Rescue rams

RZT 1-910 S-FORCE
RZT 2-1170 S-FORCE
RZT 2-1360 S-FORCE
RZT 2-1500 S-FORCE

	RZ 1-910 S-FORCE	RZT 2-1170 S-FORCE	RZT 2-1360 S-FORCE	RZT 2-1500 S-FORCE
Length	540mm	543 mm	587 mm	700 mm
Width	156 mm	156 mm	156 mm	156 mm
Height	321 mm	337 mm	345 mm	345 mm
Weight	18,4 kg	21,8 kg	21,5 kg	22,7 kg
Pushing force*	111 kN	189 kN / 99 kN	108 kN / 62 kN	108 kN / 62 kN
Closed length	540 mm	543 mm	587 mm	700 mm
Extended length	908 mm	1170 mm	1387 mm	1500 mm
Nominal pressure	700 bar	700 bar	550 bar	550 bar
EN class**	R111/368-18,4	TR189/360-99/270- 21,8	TR108/428-62/372- 21,4-E-II	TR108/428-62/372- 22,7-E-II
ID no.	1103096	1103095	1100145	1099389

* per EN 13204:2016

** in accordance with EN 13204:2016

3.5 Operating conditions

The permissible temperature range of the SMART-FORCE tools is between -20°C and +55°C. Reliable operation cannot be guaranteed outside of this range.

3.6 Type plate

The type plate for all SMART-FORCE tools is located on the bottom of the drive. It provides the serial number, production date, nominal pressure, tool designation and TIN number.

The TIN - "Tool Identification Number" is a 15-digit number and is assigned once. This is made up of the product ID and the serial number, and as such enables unique identification.

4. Structure and function

4.1 Overview of SMART-FORCE equipment

Combi tools

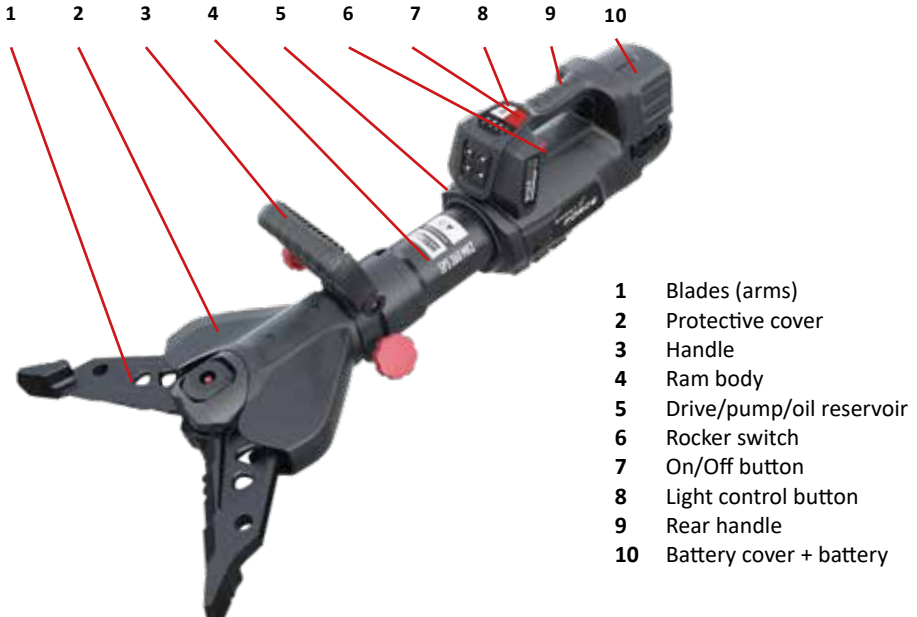

Brief description of combi tools

Battery-powered combi tools are specially designed rescue equipment for cutting and spreading vehicle body parts. They are used to rescue trapped or enclosed accident victims. The combi tool uses include cutting door and roof beams, columns and sills, as well as opening doors, lifting vehicle parts and loads, and squeezing pipes and tie bars.

Because the tools are equipped with an internal electrohydraulic drive, they are not linked to a power unit and can therefore be used in hard-to-reach locations. By using the IP 68 battery cover, underwater use is also possible.

The movement speed of the shear blades (arms) is affected by moving the rocker switch on the control handle with greater or lesser force. The maximum force is achieved only when the rocker switch is on full activation.

4.2 Cutter

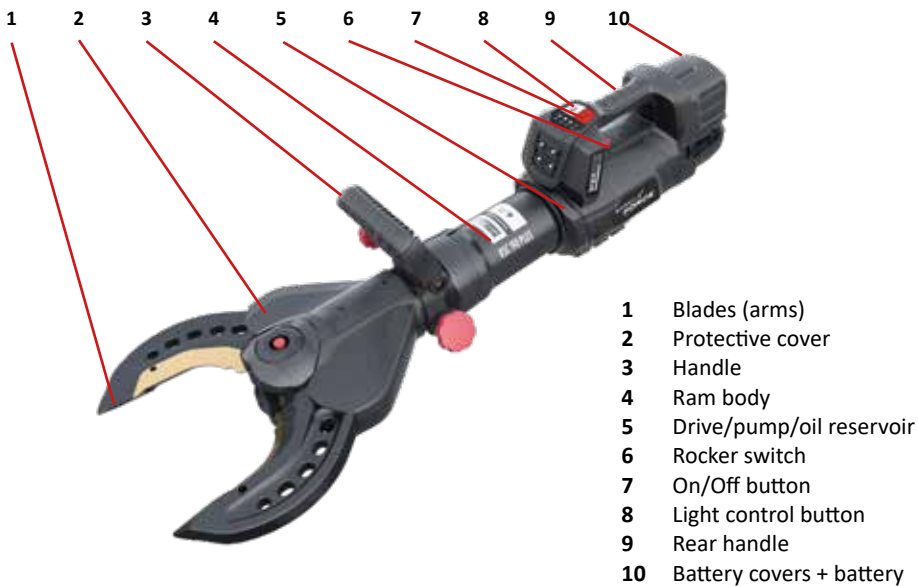

Brief description of cutter

Battery-powered cutters are specially designed rescue equipment for cutting vehicle body parts. They are used to rescue trapped or enclosed accident victims. The cutter uses include cutting door and roof beams, columns and sills.

Because the tools are equipped with an internal electrohydraulic drive, they are not linked to a power unit and can therefore be used in hard-to-reach locations. By using the IP 68 battery cover, underwater use is also possible.

The movement speed of the shear blades is affected by moving the rocker switch on the control handle with greater or lesser force. The maximum cutting force is achieved only when the rocker switch is on full activation.

4.3 Rescue rams

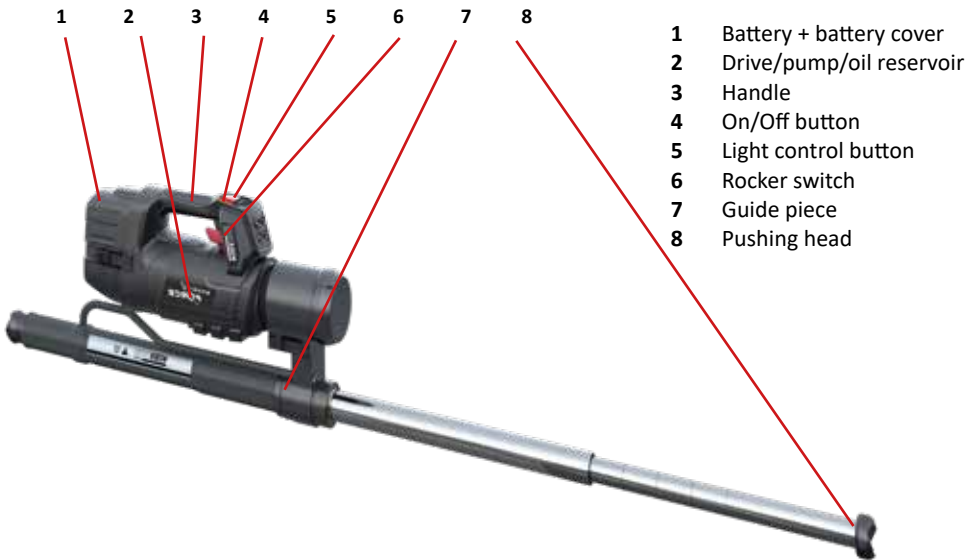

Brief description of rescue ram

Battery-powered rescue rams are specially designed rescue equipment for pushing away parts of a vehicle body. They are used to rescue trapped or enclosed accident victims. The rescue ram is suitable for tasks such as pushing up steering columns, vehicle roofs and other obstacles.

Because the tools are equipped with an internal electrohydraulic drive, they are not linked to a power unit and can therefore be used in hard-to-reach locations. By using the IP 68 battery cover, underwater use is also possible.

The rescue rams are an addition to the spreader and can be used, for example, if the spreading arm's spreading distance is no longer adequate.

The movement speed of the ram is affected by moving the rocker switch on the control handle with greater or lesser force. The maximum pushing force is achieved only when the rocker switch is on full activation.

4.4 Spreaders

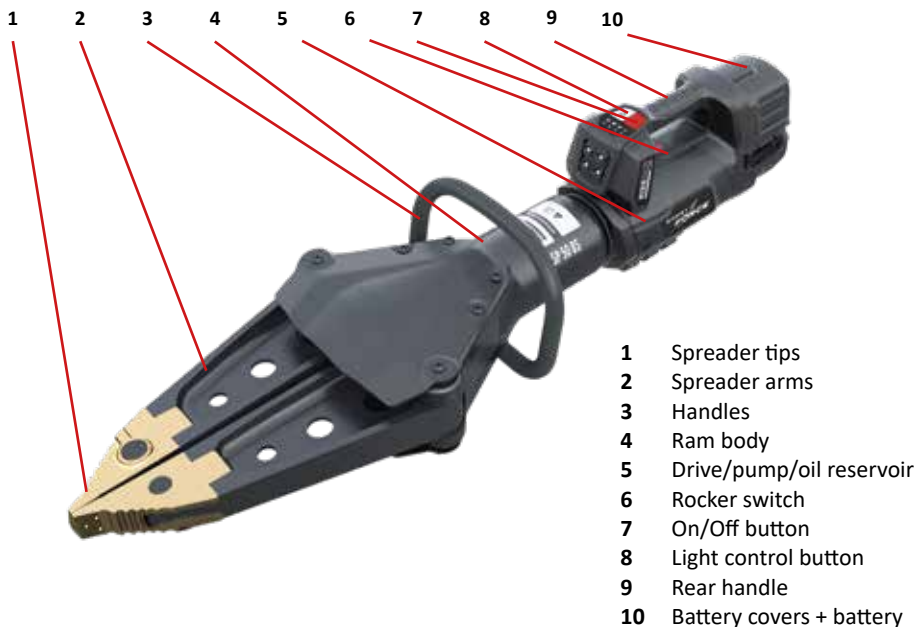

Brief description of spreader

Battery-powered spreaders are specially designed rescue equipment for spreading, pressing and pulling. They are used to rescue trapped or enclosed accident victims. The spreaders are mainly suitable for opening doors, and for lifting vehicles and other movable loads.

Because the tools are equipped with an internal electrohydraulic drive, they are not linked to a power unit and can therefore be used in hard-to-reach locations. By using the IP 68 battery cover, underwater use is also possible.

The movement speed of the spreading arms is affected by moving the rocker switch on the control handle with greater or lesser force. The maximum spreading force is achieved only when the rocker switch is on full activation.

4.5 Hydraulic supply

Drive

The battery-operated tools are powered by a 18 V DC motor. When the tool is switched on, the motor idles. Only when the rocker switch is operated does the motor start to run at a higher speed.

Pump

The hydraulic pressure is generated by a high pressure hydraulic pump (in the pump unit). The pump is a radial piston pump with 4 pump elements. The pressure is applied directly to the working cylinder, which renders the connection lines redundant.

Oil reservoir

The oil volume for operation is taken from a tank. The entire hydraulic system is therefore completely closed and free of air. The tank compensates for volume expansion caused by heat.

Hydraulic oil

All battery-powered tools should use a special hydraulic oil for rescue equipment in accordance with WN61000137. The oil does not usually need to be changed, but we recommend changing it after 10 years. An oil change can only be carried out by means of factory servicing at WEBER RESCUE Systems or an authorised service partner.



CAUTION!

Do not attempt to carry out repairs on the hydraulic system!

The complete hydraulic system is designed as a closed circuit and must therefore be completely free of air. For this reason, do not attempt to carry out repairs on the drive, to ensure that no air can enter the system!

4.6 Electrical supply, using a combi tool as an example



Figure 1: Inserting and removing the battery

Inserting/removing the battery:

Connect the battery to the rescue tool by sliding the battery into the battery holder of the tool. Make sure that the Click On/Click Off of the battery is correctly seated and locked.

To remove, press the push-buttons on both sides of the battery simultaneously and then pull the battery upwards out of the battery holder.



Figure 2: Using the half shell IP 54 cover

Using the IP 54 battery cover:

The IP 54 battery cover is used to protect the battery from mechanical damage. Before fitting the cover, make sure that the O-ring seal is correctly seated and that there is no dirt or damage to the housing in this area.

First place the IP 54 battery cover on the upper edge of the housing and then press it on fully. Close the two latches on the left and right completely. When using the IP 54 battery cover, the tool achieves protection class IP 54 = protection against moisture and splash water. Furthermore, a quick battery change is possible in regular use scenarios. To open or remove the IP 54 battery cover, fully open the two latches on the left and right and then pull the cover backwards.

4.7 Underwater use

To protect the battery and the electronics, the tool is divided into a wet and dry area. The battery, drive and electronics are protected in the rear area of the housing by the IP 68 battery cover.



Figure 3: Check the seal and the housing



Figure 4: First press the IP 68 battery cover on at the top edge of the housing



Figure 5: Completely close the latches on both sides of the battery cover

Using the IP 68 battery cover:

For underwater use, replace the IP 54 battery cover with the IP 68 battery cover supplied. Before fitting the cover, make sure that the O-ring seal is correctly seated and that there is no dirt or damage to the housing in this area. First place the IP 68 battery cover on the upper edge of the housing and then press it on fully. Close the two latches on the left and right completely. When using the IP 68 battery cover, the tool achieves protection class IP68. This means that the tool is approved for use underwater (regardless of fresh, salt and dirty water, mud, algae, silt and other contamination) to a depth of 3 m for a duration of 60 minutes.

Follow-up procedure:

Allow any water that enters the wet area of the tool to drain out completely and dry the tool before opening the IP 68 battery cover. To remove, loosen the fasteners on both sides and pull the cover off to the rear. When the tool is extended and retracted, negative or positive pressure can occur in the housing. If there is a corresponding build-up of negative pressure, the cover may be firmly attached to the housing; release the built-up negative pressure in the cover by moving it sideways. After opening the cover, carefully check whether water has penetrated - if this is the case, contact customer service. For further maintenance and care instructions after underwater use - see Chapter 9.2.



NOTE!

Underwater radio communication is not possible!

4.8 Communication module and radio connection

The communication module is installed in the rear housing component. This transmits data from the tool to an external output device via WLAN or an LTE connection - depending on the user's choice and the active operating mode. The basic hydraulic functions are always guaranteed by component separation.

To use the SMART-FEATURES and for registration, follow the instructions in Chapter 4,9.



NOTE!

The range of the radio connection can be influenced by environmental factors and is therefore dependent on many aspects such as weather, buildings, vegetation, terrain, etc. Underwater radio communication is not possible!

4.8.1 Standards and data sheets

Confirmed standards concerning electromagnetic compatibility:

EN IEC 61000-6-1:2019
 EN IEC 61000-6-2:2019
 EN IEC 61000-6-3:2006 + A1:2010
 EN IEC 61000-6-4:2019
 ETSI EN 301 489-1 V2.2.3
 ETSI EN 301 489-17 V3.2.4
 ETSI EN 301 489-19 V2.1.1
 ETSI EN 301 489-52 V1.1.0

Confirmed standards concerning radio communication:

ETSI EN 301 511 V12.5.1 (2017-03)
 ETSI EN 301 908-1 V13.1.1 (2019-1)
 ETSI EN 300 328 V2.2.2 (2019-07)
 ETSI EN 301 893 V2.1.1 (2017-05)
 ETSI EN 303 413 V1.1.1 (2017-06)

4.8.2 Information regarding radio channels used

WIFI range: Frequencies:	Frequency range:	Channel width: Broadband	4G range:	2G range
3b	2400MHz-2483.5MHz	Number of RF channels:	B1 (2100), B2 (1900),	B2 (1900)
GNSS:	5150MHz-5350MHz	WIFI 2.4GHz: 13	B3 (1800), B4 (AWS 1700),	B3 (1800)
Ae1	5150MHz-5350MHz	WIFI 5GHz: 9	B5 (850), B8 (900)	B5 (850)
Ae2	5470MHz-5725MHz		B12 (700), B13 (700),	B8 (900)
L1			B18 (800), B19 (800)	
			B20 (800), B26 (850),	
			B28 (700)	

GNSS Constellation	GNSS Signal Designations	RNSS Frequency Band (MHz)
BDS	B1I	1 559 to 1 610
	B2C	1 559 to 1 610
Galileo	E1	1 599 to 1 610
	E5a	1 164 to 1 215
	E5b	1 164 to 1 215
	E6	1 215 to 1 300
GLONASS	G1	1 559 to 1 610
	G2	1 215 to 1 300
GPS	L1 C/A	1 559 to 1 610
	L1C	1 559 to 1 610
	L2C	1 215 to 1 300
	L5	1 164 to 1 215
SBAS	L1	1 559 to 1 610
	L5	1 164 to 1 215

All exceptions: E5 - E6 - G2 - L2C - L5

4.8.3 Transmission power

- 2G LB max. 32dBm 2G HB max. 28dBm
- 4G FDD max. 23dBm @1RB

4.8.4 Receiving sensitivity

- 2G -> sensitivity of -107dBm
- 4G FDD (BW=5MHz) -> sensitivity of -102dBm

4.8.5 Labels country-specific radio approvals

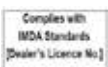
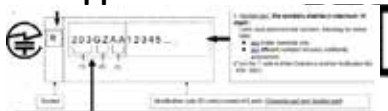

Contains FCC ID: XXXXXXXXXXXXXXXXX

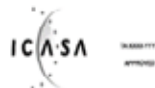

4.9 Operating SMART-FORCE equipment

To start the battery-operated tool, press the on/off switch. The workspace lighting LEDs switch on and the four control LEDs on the control panel briefly light up green; this is a control function. The motor begins to idle. In this state, if the tool is not operated using the rocker switch on the control handle, the drive switches off automatically after 30 seconds and must then be restarted. However, the data connection remains active for a further 2 minutes and only switches off completely once this time has elapsed.

Pressing the rocker switch on the control handle harder or less hard adjusts the movement speed. The maximum cutting, expansion or pushing force is only obtained by fully depressing and holding the rocker switch.

Closing the cutter / Opening the spreaders / Extending the rescue ram

The main direction of tool movement is triggered by pressing the rocker switch to the left with your index finger (grooved/convex side of the rocker switch).

Opening the cutter / Closing the spreaders / Retracting the rescue ram

The opposite direction is triggered by pressing the control rocker to the right with your thumb (curved/concave side of the rocker switch).

Dead man's circuit

When the rocker switch is released, it returns to the zero position automatically. This always brings the tool to a stop in any situation, including under load. The motor switches off automatically after 30 seconds.

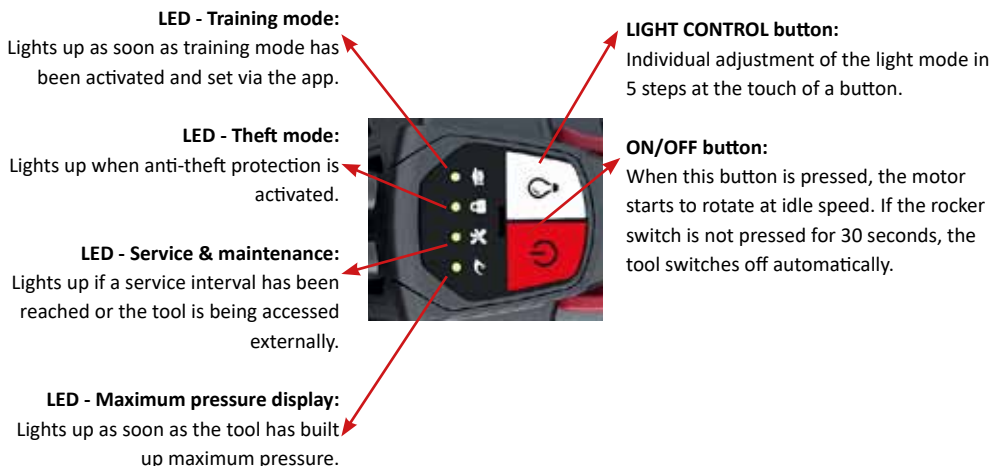

4.10 Operating SMART-FORCE equipment

Die Betriebsanleitung für die SMART-features ist online abrufbar unter folgendem link:
hub.weber-rescue.com/manual/

4.11 Device registration for SMART-FORCE rescue devices

An account in the WEBER RESCUE hub is required for device registration. An existing account can also be used for this purpose.

Who should register the SMART-FORCE device?

To ensure a person-independent and transparent registration of your SMART-FORCE device, an internal concept for the main account as well as the individual subprofiles and the respective assigned authorizations in the digital world of WEBER RESCUE is necessary. It is important to avoid creating a separate account for each device.

Our recommendation: Create a main account for the fire department or for your organization, to which all tools are registered. These can then be additionally assigned to different stations and vehicles from this account. Afterwards, special personal profiles with sub-authorizations can be assigned again for each device.

1. Scan the QR code below or open our device registration website in your browser:
hub.weber-rescue.com/geraeteregistration
2. If you already have an account for another WEBER RESCUE digital solution or app, you can log in with your existing credentials and add the new SMART-FORCE device by providing its unique TIN number.
3. If you do not yet have an account in the WEBER RESCUE digital world, then you can quickly and easily create your SMART-FORCE device by clicking on the „Register“ button in the top right corner. A user account will then be created automatically.
4. The TIN number required for registration can be found on the type plate of your SMART-FORCE device. The activation code in the separate flyer "Device registration".



4.12 Accessories

Combi tools



Shear blades



Pulling device



Chain set



RZM



Transport case

ID no.	SPS 270 MK2 S-FORCE	SPS 360 MK2 S-FORCE	SPS 370 MK2 S-FORCE	RIT-TOOL S-FORCE	SPS 400 MK2 S-FORCE	SPS 480 MK2 S-FORCE
Shear blades	1101470	1101471	1101472	1101159	1100144	1085938
Tips	-	-	1050616			
Pulling device	1103553	2835746	2836033			
Chain set	2819139	2819139			1095147	
RZM	1094619		1094618 + 1094618BLK			-
Transport case	1058128					



PLUS shear blade without insert



PLUS shear blade insert



PLUS shear blade with insert



PLUS shear blade inserts in case



Shear blades

ID no.	RSC 170 PLUS S-FORCE	RSC 190 PLUS S-FORCE	RSC200 PLUS S-FORCE
Shear blades without inserts	1099757	1099397	1100689
Shear blade insert	1099753	1099753	1100690
Shear blade with insert	1099758	1099396	1100686
Shear blade inserts in bag	1103455	1103455	1105462
Shear blades for RSC 170 S-FORCE	1099451		
Shear blades for RSC 190 S-FORCE	1099309		
Shear blades for RSC 200 S-FORCE	1099765		
Shear blades for RSC F 7	1101226		

Spreader



Replacement tips



Chain set

ID no.	SP 44 AS	SP 54 AS / SP 50 BS
Replacement tips	1091176	1091849
Chain set	2819139	571415
Door opening tips	-	1100623

S-FORCE tool accessories

	ID no.
Replacement battery M18 5.5HB Milwaukee	1101254
Replacement battery M18 8.0HB Milwaukee	1099928
Replacement battery M18 12.0HB Milwaukee	1099929
Battery case	1056921
Strap for battery case	1056920
Mains charger M12-18 FC - 110V RAPIDCHARGER	1102000
Mains charger M12-18 FC - 230V RAPIDCHARGER	11011257
Mains charger M12-18 SC - 230V SUPERCHARGER	1101265
Mains charger M18 DFC - 230V double charger for 2 batteries	1101263
Mains charger M1418C6 - 230V multi charger for 6 batteries	1101264
Automotive charger M12-18 AC - 12V	1101262
Continuous power supply - power adapter 110 V	1099998
Continuous power supply - power adapter 230 V	1099997
IP 68 battery cover (for 5.5 Ah and 8.0 Ah battery)	1099894
IP 54 battery cover (for 5.5 Ah and 8.0 Ah battery)	1099352
IP 54 battery cover (for 5.5 Ah, 8.0 Ah and 12.0 Ah battery)	1101405

4.13 Replacing blade inserts (PLUS)

During a change of blades, ensure the cutter is fixed in place. Any movement should be avoided. Replacing the blade requires a soft-face hammer, the tensioning pins supplied, the punch and the blade inserts themselves. It is practical to replace both blade inserts to continue enjoying optimum cutting performance.



NOTE!

The blade inserts should not be reground, simply cleaning off any debris is recommended.

Procedure:



Fig. 1

When the blade insert is being changed, the battery must be removed from the tool. The cutter blades are wide open (see Fig. 1) but the cutter is not under load. This means that the cutter is not completely open or closed. Now the blade insert can be changed on the cutter blade with the smooth surface, using the punch to knock out the tensioning pin downwards (see Fig. 1 - Knocking out the tensioning pin).



Fig. 2

After the tensioning pin has been knocked out of its position, the blade insert can be pulled out. If the blade insert is stuck, it is advisable to lever it slightly with the punch in the holes and thereby loosen it. (see Fig. 2 - Loosening the blade insert)



Fig. 3

Carefully remove dirt and grime before inserting the new blade insert. (see Figure 3 - Removing dirt). When inserting, make sure that the blade insert does not tilt. To do this, approach with the rounded side of the insert first.



Fig. 4

If the blade insert cannot be inserted by hand, it is advisable to use lubricant and a soft-face hammer. (see Fig. 4 - Inserting the new blade insert)

After the new blade insert has been fully inserted, the blades are turned and the tensioning pin is driven in again from the rear. (see Figure 5 - Driving in the tensioning pin). Make sure that the tensioning pin is fully driven in again with the punch. (see Fig. 6 - Fully hammering in the tensioning pin)



Fig. 5

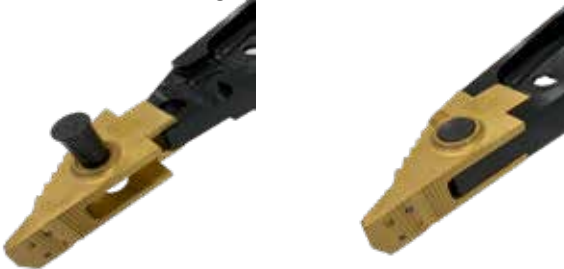

Fig. 6

4.14 Replacing the spreader tips

The spreader tips of the SP 50 BS and the SP 54 AS are secured with captive collar pins in the spreader arms. To replace them, the pins must be pushed out. After the tips have been replaced, the collar pins can be pushed back through. Check that the pins are seated correctly (pressed completely in).

The holder for the chain set must be mounted in identical fashion. The chain lock must be installed with the latch facing upward.



The collar pins on the spreader tips can be pressed out of the spreader arms but have a safeguard device to prevent them being lost and so they cannot be separated from the tips.

The SP 44 AS spreader tips are not secured with removable collar pins but rather with a tensioning pin that must be knocked out when the tips are being changed. The chain set can be fastened in a separate hole without having to remove the tips beforehand.



CAUTION!

During operation, special care must be taken to ensure that the collar pin remains fully closed.



CAUTION!

Ensure that the door opening tips always have full-surface contact!

If the optionally available door opening tips are attached to the combi tool or spreader, they must always be inserted into the gap while ensuring full-surface contact. Furthermore, reposition as often as possible to insert the teeth at least 20 mm into the gap. Otherwise, the tip may break when the tool is fully loaded.

5. Applications

5.1 Safety instructions

**WARNING!**

Never reach between the blade or spreader arms!

**WARNING!**

During any work with battery tools, tensioned parts can break or fly off, thereby endangering people.

Uninvolved parties must therefore remain a safe distance away or stay in the danger zone only as long as necessary.

5.2 Cutting (cutters, combi tools)

The cutting performance of the tool can only be optimally utilised if they are placed as near as possible to the blades pivot point (Fig. 1).

The tool may have to be moved back to do this.

The tool only achieves full cutting performance when the rocker switch is fully depressed. Furthermore, it may take a few seconds until the hydraulic pump reaches the maximum working pressure.



Fig. 1



Fig. 2

Always cut at a right angle to the cutting material, in order to prevent damage to the blades. Also, the tips of the shear blades must not be more than 5 mm apart during the cutting process. If this value is exceeded, the cutting process must be cancelled and then started again.

**CAUTION!**

Do not sever any parts with loose ends, because this can result in personal injury due to parts flying off.

**ATTENTION!**

When cutting high-strength vehicle body parts, such as shock absorbers, hinges or steering columns, the shear blades (arms) may cause severe damage.

5.3 Pressing (rescue rams)

In its closed state, the rescue ram is positioned for pushing away vehicle body parts. Therefore, make sure that the ram is placed as centrally as possible and at a right angle to the load.

The pushing head can be rotated on the piston rod to guarantee better attachment options.

5.4 Spreading (spreaders, combi tools)

The spreading functions can be used to open doors, lift vehicles and other movable loads, push vehicle parts away, and squeeze pipes and tie bars. For this, the vehicle must be stably positioned and supported.

To prevent any sliding during spreading, the arms and tips are serrated inside and out. Spreader tips also have spikes for particularly good grip. Additionally, slipping is prevented through early repositioning of the spreader tip.

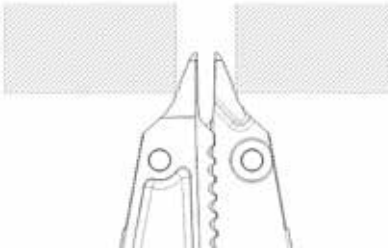
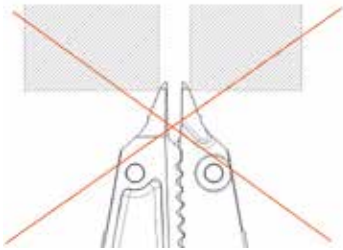
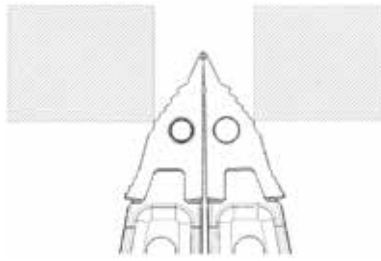
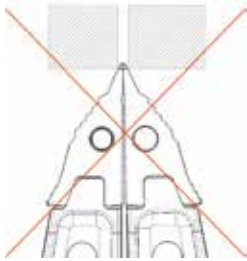

5.5 Pulling (spreaders, combi tools, rescue rams)

After the chain set (as described in Chapter 4.7) has been attached to the equipment, spreaders, combi tools and rescue rams can also be used for pulling.

For this, the chains must be tightly tensioned and must be tensed only in the pulling direction. To tension the chain, only one lock can be pressed in, so that the chain can be pulled through the chain lock.

If the range of movement is insufficient, tension chains or other means must be used so that the tool can be reopened and the chain tensioned again.



ATTENTION!

For quick use, it is advisable to keep the pulling chain with the chain locks mounted approx. 10 - 20 cm from the end. Carefully check the chains prior to every use. Check that the weight does not stress the tip of the hook, but lies in the middle of the hook instead.

- » You must not undertake any repairs yourself.
- » Never load chains greater than the load capacity indicated.
- » Do not shock-load.
- » Do not galvanise or paint the chains.
- » Do not shorten the chains by knotting.
- » Do not apply heat to the chains.
- » Only use the chains and accessories between temperatures of – 40°C and +200°C.
- » When undertaking maintenance work on the chains, the Accident Prevention Regulations and the requirements of DIN EN 818-7 and DIN 685-5 must be observed.
- » Chains must only be used for lashing. Lifting loads is not permitted.

Chains may not be used again if:

- » They are deformed, cracked or exhibit corrosion pitting.
- » The diameter of the metal forming the chain link has reduced by 10 % of the nominal thickness.
- » An individual chain link has been permanently stretched.
- » An individual link has been enlarged by more than 2%.
- » The internal chain pitch over a measuring distance of 11 chain links has increased by more than 2%.

5.6 Squeezing (spreaders, combi tools)

The squeezing of pipes and other hollow profiles takes place by closing the spreader arms. However, with the combi tools, squeezing can only be done in the area of the tips!

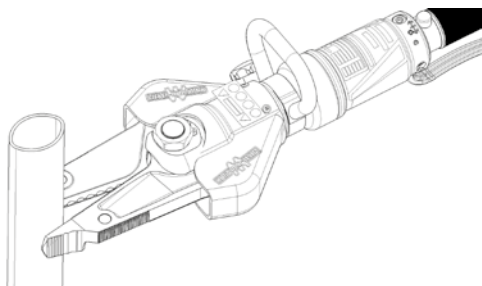
**ATTENTION!**

Material to be squeezed can suddenly spring away.
Do not remain in the working area of the spreading and combi tools!

5.7 Lifting (spreaders, combi tools, rescue rams)

Spreaders, combi tools and rescue rams can be used for lifting vehicles or other movable loads on one side. Care must be taken to secure the load against slipping away and to position the spreader tips far enough apart under the load to prevent slipping.

The load being lifted must be constantly monitored (tipping, rolling away or changing position). Furthermore, the lifted load must be immediately propped up and supported in a suitable way. Avoid remaining beneath loads!

Under special conditions, rescue rams can also be used to lift loads. When doing so, make especially sure that the ram is placed as centrally as possible and at a right angle beneath the load.



NOTE!

Before a rescue ram is used, the attachment point must be supported so that force develops in the desired direction.



NOTE!

Complete lifting of loads is not permitted with rescue equipment.

5.8 Peeling (spreaders, combi tools, rescue rams)

To create entry openings after bus and train accidents, in silos, etc., both the spreader tips and the peeling tool can be used.

5.9 Pressing (combination appliances with RZM)

To further increase the spreading distance of the combination devices, a mechanical rescue ram can be optionally fitted to these devices. This is inserted into the scissor blades using spring-loaded bolts.

The blades should be slightly open so that the RZM can be used more easily!

If you now move the scissor blades of the combi tool apart, the RZM also opens.



NOTE!

The RZM cannot be used in conjunction with the SPS 480 MK2 combination device.

6 Battery and charger

6.1 Charger technical data



	ID no.	5,5 Ah	8,0 Ah	12 Ah
M12-18 FC - 110V RAPIDCHARGER	1102000	60 min	87 min	130 min
M12-18 FC - 230V RAPIDCHARGER	1101257	60 min	87 min	130 min
M12-18 AC - 12V car charger	1101262	130 min	190 min	285 min
M12-18 SC - 230V SUPERCHARGER	1101265	35 min	45 min	60 min
M18 DFC - 230V double charger for 2 batteries	1101263	60 min	87 min	130 min
M1418C6 - 230V multi charger for 6 batteries	1101264	125 min	190 min	270 min

6.2 Special safety instructions



WARNING!

Do not throw used batteries into domestic waste or into the fire. Your specialist dealer can dispose of your old battery in an environmentally friendly manner.

The following batteries can be charged with the chargers and are intended for use in combination with our rescue equipment:

Battery type	ID no.	Voltage	Nominal capacity	Weight
M18 HB5.5	1101254	18V	5,5 Ah	1,1 kg
M18 HB8	1099928	18V	8,0 Ah	1,1 kg
M18 HB12	1099929	18V	12,0 Ah	1,7 kg



ATTENTION!

Only the batteries listed in the table should be used to operate S-FORCE rescue equipment. Care must be taken to use Milwaukee's High Output Series.

**WARNING!****Important safety instructions concerning the battery and the charger.**

- » The charger cannot be used to charge non-rechargeable batteries.
- » Do not store batteries together with metal items (risk of short circuit).
- » Metal parts must not get into the battery insertion slot on the chargers (risk of short circuit).
- » Do not open batteries or chargers, and only store in dry rooms. Protect against moisture.
- » Mains voltage is present at the charger. Do not reach into the tool with objects that can conduct electricity.
- » Do not charge a damaged battery. Replace it immediately.
- » Check the tool, connection cable, battery pack, extension lead and plug for damage and ageing. Have damaged parts repaired only by a specialist.
- » This tool is not intended to be used by people (including children) with limited physical, sensory or mental capabilities, or who have a lack of experience and/or a lack of knowledge, unless they are supervised by a person responsible for their safety or have received instructions from him/her on how to use the tool. Children must be supervised to ensure that they do not play with the tool.
- » Before underwater use, the IP 68 battery cover required for this purpose must be fitted and further preparatory measures must be taken as described in Chapter 4.7.

6.3 Intended use

The chargers listed in the table are approved for charging the 18V Li-Ion batteries of the M18/V18 system supplied with the battery tool.

6.4 Mains connection

Only connect to single-phase alternating current and only to the mains voltage specified on the rating plate. It can also be connected to sockets without an earth contact as it is built in accordance with protection category II.

6.5 Li-ion battery

For safety reasons, the batteries are discharged when they are delivered (air transport regulation). The battery must be charged completely before first use.

LED charging status indication



If the battery is not used for a longer period of time, it switches to idle mode. The battery must be re-activated (charged) in order to be used again.







The charging status can be checked by pressing the button on the battery (see illustration). The battery can remain in the charger for this but the charger must be switched off at least 1 minute before (otherwise the indication will be inaccurate). The number of glowing LEDs indicates the charge status.

As a matter of principle, the following applies: If the battery tool does not work after inserting the battery, plug the battery into the charger to check it. The indications on the battery and the charger then provide information on the battery condition.

You can continue to work with reduced power at lower temperatures. For best operational readiness, the batteries must be fully charged after use. The batteries have special protection against deep discharge.



LIGHT INDICATORS

	Continuous red	Charging
	Slow flashing green	Approaching full charge
	Continuous green	Charging is complete
	Fast flashing red	Battery is too hot/cold - Charging will begin when battery reaches correct charging temperature
	Slow flashing red	Battery charge is pending - Charging will begin when the first pack is fully charged
	Flashing red/green	Damaged or faulty battery pack

Quelle: Milwaukee, 2022

6.7 Maintenance

If the power cable is damaged, it must be replaced by a customer service centre.

Only use approved accessories and approved spare parts. If a replacement description is not provided for a component, have it replaced by an authorised customer service location.

7 Transport, packaging and storage

7.1 Safety instructions

**CAUTION!****Damage due to improper transport!**

Improper transport can cause considerable property damage.

Therefore:

- » When unloading the packaged pieces, proceed with caution and pay attention to the symbols on the packaging.
- » Only completely open and remove packaging at the actual storage site.

7.2 Transport inspection

Check the delivery immediately after receiving it for completeness and possible transport damage so that, if needed, a remedy can be found quickly.

If there is any externally visible damage, proceed as follows:

- Refuse the delivery or accept it with reservation.
- State the extent of damage on the transport documents or the transporter's delivery receipt.
- Initiate complaint.

**NOTE!**

Report every deficiency as soon as it is recognised.

Damage claims can be directed to our Customer Service (see Chapter 1.6).

7.3 Symbols on the packaging

**Caution - fragile!**

Handle the package carefully, do not drop it, throw it, hit it or tie it down.

**Facing upwards!**

The package must always be transported and stored with the arrows pointing upwards. Do not roll or tilt.

7.4 Disposal of packaging



Properly dispose of all packaging materials and parts that have been removed (transport protection) in accordance with local regulations.

7.5 Storage

To the greatest extent possible, store the equipment in a dry, dust-free area. Avoid exposing the tool to direct UV radiation.

**CAUTION!**

The tool must be stowed securely in the brackets provided in order to avoid damage during transit, etc.

**NOTE!**

To maintain battery performance, store batteries fully charged at ambient temperature. Regular charge/discharge cycles contribute to the longevity of batteries.

8 Installation and commissioning

8.1 Safety instructions

**WARNING!****Danger of injury due to improper operation!**

Improper operation can cause severe injury or property damage.

Therefore, it is absolutely necessary to:

- » Carry out all work steps according to the information in these operating instructions.
- » Before starting work, ensure that all covers and guards are installed and that they work properly.

Personal protective equipment

Wear protective equipment as specified in Chapter 2.4 when performing all work!

**NOTE!**

Special attention is drawn to the need for further protective equipment to be used with certain items of work involving one or more of these equipment.

8.2 Checks

Inspect the SMART-FORCE tool for damage. Never use the tool unless it is in flawless condition! In this case immediately notify your supplier.

SMART-FORCE combi tools, cutters and spreaders:

- Check the blades (for damage)
- Inspect the spreader tips (for damage)
- Check the membrane keypad and the rocker switch (function)
- Check the handle (fastened securely)
- Check the cover plate (damage)
- Check the latching of the battery cover and the battery retaining plate
- Perform the self-test function

SMART-FORCE rescue ram:

- Check the piston rod (damage)
- Check the membrane keypad and the rocker switch (function)
- Check the pressure elements (damage)
- Perform the self-test function
- Check the latching of the battery cover and the battery retaining plate

8.3 Shut-down (end of work)

Cutters:

After work is over, the blade tips must be placed one above the other to prevent injury. Never close the blades of the cutter completely so that the hydraulic load on the cutter is relieved for storage.

Rescue rams:

After work is over, the ram's piston rod must be completely retracted, so as to relieve the hydraulic load on the tool by extending it briefly (1-5 mm).

Combi tools and spreaders:

Once work has finished, the spreader arms must remain slightly open in order to relieve the tool's hydraulic pressure.













8.4 Advantages of device registration

What are the advantages of device registration for SMART-FORCE rescue equipment?

With the new SMART-FORCE battery-powered tool series, Weber Rescue SYSTEMS is heralding a digital revolution in the rescue tool market.

More speed, a powerful and Milwaukee compatible 18V battery, intuitive design as well as numerous smart features packed into a robust and submersible housing. To be able to use the smart features of your SMART-FORCE device without restrictions via web interface and app, it is necessary that you register your device online.

The registration process activates the SIM card in the device, which enables data transfer. At the same time, you can store settings for the device and the respective authorization profiles via the app or the web interface. Explicit consent to the privacy policy of the device owner is required for device registration.

- | | | | |
|---|-----------------------------|--|---------------------|
|  | WLAN und LTE |  | Service information |
|  | GPS |  | Telemetry |
|  | Devicemanagement |  | Safety Stop |
|  | Authorization profiles |  | Quicktest |
|  | SMART-FORCE App |  | Theft protection |
|  | Device status and telemetry |  | Training mode |



More information on the smart functions and features of the SMART-FORCE rescue equipment can be found at www.weber-rescue.com/en/smart-force

More Information

9 Maintenance

9.1 Safety instructions

**WARNING!****Danger of injury due to defective maintenance work!**

Improper operation of the tool can cause severe injury or property damage.

Therefore, it is absolutely necessary to:

- » Have all maintenance work carried out by trained specialists.
- » Ensure good housekeeping and cleanliness at the workplace! Loose components and tools left lying around constitute a potential hazard.
- » Wear protective gloves during all work!

9.2 Upkeep and maintenance

To be ready for operation at any time, the following measures are absolutely imperative:

- After every load, but at least once a year, visually check the tool and its accessory parts.
At this time, pay particular attention to spreader tips, blades, housing and seal on the battery cover.
- Every three years, or whenever a doubt is raised about the safety or reliability of the tool, a function and load test must also be carried out (per DGUV guideline 305-002 or country-specific regulations).
- After every load, check the lubrication of the movable parts and pins, and spray with suitable grease if necessary. Special attention should be paid to lubrication via the lubrication groove provided for this purpose on the spreaders, as well as the grease nipple on the cutters.
- Every 10 years we recommend a complete change of the hydraulic oil by our factory service to maintain full performance.

**ATTENTION!**

Prior to all maintenance work, the equipment must be cleaned of any dirt so that it does not get into the hydraulic system. Cleaning can be carried out using a conventional cleaner.

9.3 Maintenance after operation in humidity

- The tool must be dried after being operated in damp conditions
- Browned parts (bolts, blades and clips) must be greased

9.4 Maintenance after underwater use

- If the tool becomes dirty, rinse it thoroughly with clean water to remove mud, silt, algae, salt water or other contaminants.
- After operation under water or in damp conditions, drain the water from the front area of the tool. The tool must then be dried.
- Check the seal on the battery cover and the housing. If water enters the battery cover - contact your service partner.
- Burnished parts (bolts, blades and lugs) must be greased and preserved - see also chapter 9.3.
- The appliance remains ready for use after underwater use and after observing the above points. Contact your service partner for thorough preparation and cleaning of the device.
- After use in dirty and/or salt water, we recommend extensive rinsing with clear water.

9.5 Maintenance schedule

For an exact maintenance schedule with inspection intervals, regulations and reports, see DGUV guideline 305-002, point 18 (hydraulically-actuated rescue equipment).

**ATTENTION!**

In case of problems with the device maintenance, our customer service is at your disposal (see chapter 1.6).

10 Malfunctions & faults

Combi tools & cutters:

Malfunction	Possible cause	Remedy
Tool does not reach full performance	Rocker switches not completely pressed to the side	Press the rocker switches completely to the side
Combi tool moves in opposite direction under load	Check valve defective	Have the tool checked by an authorised service centre.
Blades are loose and gape apart during cutting	Blade not attached to the shear head as specified	Repair work by an approved workshop
Blade opening below target value	Shearing head settings altered	Repair work by an approved workshop
Combi tool opening width below target value	Shearing head settings altered	Repair work by an approved workshop
Pressure build-up despite movement (open - closed) without a load	Hex nut / central bolt too tight	Repair work by an approved workshop
Blade chipping	Blades damaged e.g. from cutting high-strength materials	Re-sharpenable to about 2 mm (see repair manual) otherwise replace
Cracks in the blades	Blades damaged e.g. from cutting high-strength materials	Have the blades replaced by an authorised service centre
Rescue equipment does not function	Battery is dead	Place the battery on the charger. The displays on the battery and charger give information about the battery charge status
Water ingress in the underwater battery cover	O-ring seal defective or dirty	Replace and lubricate the O-ring seal

Rescue rams:

Malfunction	Possible cause	Remedy
Tool does not reach full performance	Rocker switches not completely pressed to the side	Press the rocker switches completely to the side
Ram moves in opposite direction under load	Check valve defective	Have the tool checked by an authorised service centre
Rescue equipment does not function	Battery is dead	Place the battery on the charger. The displays on the battery and charger give information about the battery charge status

Spreaders:

Malfunction	Possible cause	Remedy
Tool does not reach full performance	Rocker switches not completely pressed to the side	Press the rocker switches completely to the side
Spreader moves in opposite direction under load	Check valve defective	Have the tool checked by an authorised service centre
Rescue equipment does not function	Battery is dead	Place the battery on the charger. The displays on the battery and charger give information about the battery charge status

11 Decommissioning / recycling

After its operating life has expired, dispose of the tool properly. However, individual parts can be reused.

The hydraulic oil must be drained completely and caught. Note that hydraulic oil must be disposed of separately!

The local disposal requirements are applicable to disposal of all equipment parts and packaging materials.

Do not dispose of electrical tools with domestic waste! In accordance with European Directive 2002/96/EC about old electrical and electrical equipment as implemented in national law, used electrical equipment must be separately collected and passed on for environmentally responsible recycling.



NOTE!

Please ask your supplier about disposal of the equipment.

12 EC Declaration of Conformity



WEBER-HYDRAULIK GMBH
Emil Weber Platz 1, A-4460 Losenstein, Austria



DECLARATION OF CONFORMITY

according to Directive 2006/42/EC

Herewith we declare, that our "Hydraulic rescue Equipment"

SPREADERS	SP 44 AS S-FORCE, SP 50 BS S-FORCE, SP 54 AS S-FORCE
CUTTERS/COMBI-TOOLS	RSC 170 (PLUS) S-FORCE, RSC 190 (PLUS) S-FORCE, RSC 200 (PLUS) S-FORCE, RSC F7 S-FORCE RIT-TOOL S-FORCE, SPS 270 MK2 S-FORCE, SPS 360 MK2 S-FORCE, SPS 370 MK2 S-FORCE, SPS 400 MK2 S-FORCE, SPS 480 MK2 S-FORCE
RAMS	RZ 1-910 S-FORCE, RZT 2-1170 S-FORCE, RZT 2-1360 S-FORCE, RZT 2-1500 S-FORCE
POWERSUPPLY	Battery 5,5 Ah, Battery 8,0 Ah, Battery 12,0 Ah Battery charger's (tested by sub supplier- see separate CE- certificate's)
ACCESSORIES	and accessories to all tools

meets the relevant basic safety and health requirements of the Directive
EC-MACHINE DIRECTIVE 2006/42/EC
EC-LOW VOLTAGE DIRECTIVE 2014/35/EC
EC-ELECTROMAGNETIC COMPATIBILITY DIRECTIVE 2014/30/EU
EC-DIRECTIVE RoHS 2011/65/EU
EC-RADIO EQUIPMENT DIRECTIVE 2014/53/EU

For the relevant implementation of the safety and health requirements mentioned in the directives, the following standards and or technical specifications has been respected:

EN 13204 : 2016	EN 61000-6-1: 2019	EN ISO 13857 : 2019
NFPA 1936 : 2020	EN 61000-6-2: 2019	EN ISO 12100 : 2010
DIN 14751-4: 2011-04	EN 61000-6-3: 2006 + A1:2010	EN ISO 13849-1 : 2008
EN 61508-1: 2011	EN 61000-6-4: 2019	IEC 82079-1 : 2021
IEC 62443: 2020	EN60529 : 1991 + A1:2000 + A2:2014	ETSI EN 301 489-1 V2.2.3
ETSI EN 301 489-17 V3.2.4	ETSI EN 301 489-19 V2.1.1	ETSI EN 301 489-52 V1.1.0
ETSI EN 301 893 V2.1.1:2017-05	ETSI EN 301 511 V12.5.1:2017-03	ETSI EN 301 908-1 V13.1.1:2019-1
ETSI EN 300 328 V2.2.2:2019-07	ETSI EN 303 413 V1.1.1:2017-06	

The tools are tested according to EN 13204:2016 and NFPA 1936:2020
 Authorised person to compile the technical file(s): Josef Eder Head of Development

Losenstein, 02.04.2023

WEBER-HYDRAULIK GMBH
A-4460 Losenstein - Emil Weber Platz 1

i.A. Hannes Buchner
(Product Manager)

i. V. Josef Eder
(Head of Development)

WEBER-HYDRAULIK GMBH

Heilbronner Straße 30
74363 Güglingen, Germany
Phone +49 7135 71-10270
Fax +49 7135 71-10396

Emil Weber Platz 1
4460 Losenstein, Austria
Phone +43 7255 6237-120
Fax +43 7255 6237-12461

www.weber-rescue.com